

VISO BATH

PROMOBATH 15

DISFRUTA DE TU
BAÑO

MUEBLES, LAVABOS Y ESPEJOS
DISEÑADOS PARA TI

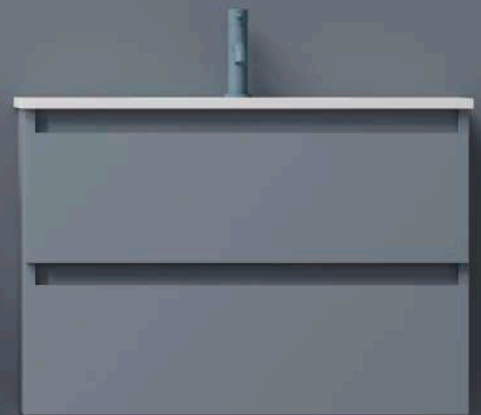
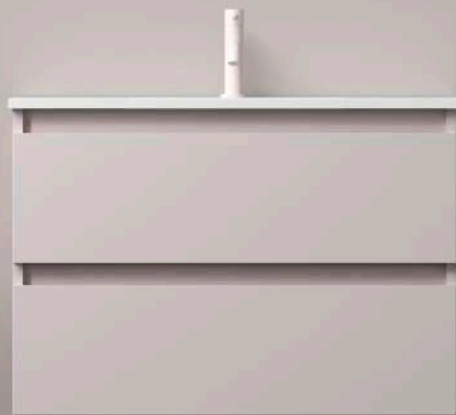
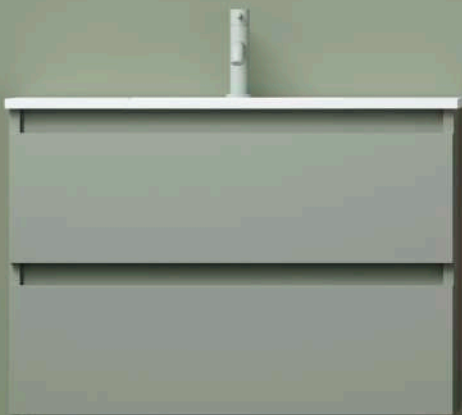

LO ÚLTIMO EN DECORACIÓN
PARA UN BAÑO A LA MODA

INSPIRACIÓN Y
TENDENCIAS
2024

**PON COLOR
EN TU BAÑO**

NUEVOS ACABADOS
MATE QUE APORTAN
ESTILO Y MODERNIDAD

Es im- posible elegir uno



Nuestra colección Box ahora disponible en acabados mate en tendencia.

Descubre toda la moda para baño en nuestro nuevo catálogo general 6.0

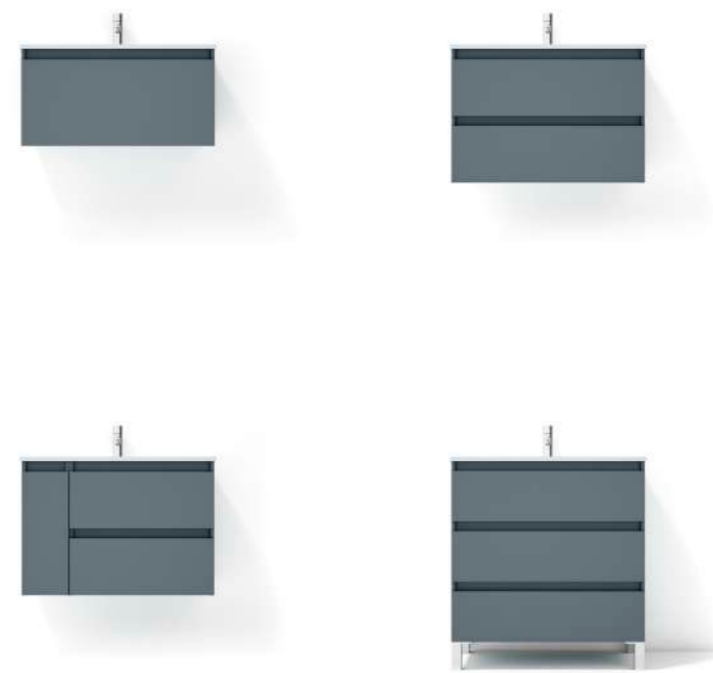

Espejo Capri
Ref. 87660
P. 109



MUEBLE 60 + LAVABO FLAT
309€

AQUA

MUEBLE 2C + LAVABO FLAT

| | 60cm | | | 70cm | | | 80cm | | | 100cm | | |
|------------|-------------|-------------|-----------|-------------|-------------|-----------|-------------|-------------|-----------|-------------|-------------|-----------|
| | Tir.Grafito | Tir. Cuarzo | Tir. Alu. | Tir.Grafito | Tir. Cuarzo | Tir. Alu. | Tir.Grafito | Tir. Cuarzo | Tir. Alu. | Tir.Grafito | Tir. Cuarzo | Tir. Alu. |
| Aliso | 72092 | 72110 | 73875 | 78174 | 78180 | 78186 | 72098 | 72116 | 73881 | 72104 | 72122 | 73887 |
| Valenti | 72093 | 72111 | 73876 | 78175 | 78181 | 78187 | 72099 | 72117 | 73882 | 72105 | 72123 | 73888 |
| B-ada | 72094 | 72112 | 73877 | 78176 | 78182 | 78188 | 72100 | 72118 | 73883 | 72106 | 72124 | 73889 |
| Ceniza | 72095 | 72113 | 73878 | 78177 | 78183 | 78189 | 72101 | 72119 | 73884 | 72107 | 72125 | 73890 |
| Avio | 72096 | 72114 | 73879 | 78178 | 78184 | 78190 | 72102 | 72120 | 73885 | 72108 | 72126 | 73891 |
| Quarzo | 72097 | 72115 | 73880 | 78179 | 78185 | 78191 | 72103 | 72121 | 73886 | 72109 | 72127 | 73892 |
| PVP | 309 | | | 339 | | | 349 | | | 408 | | |

MUEBLE 2C + LAVABO ADA

| | 60cm | | | 80cm | | | 100cm | | |
|------------|-------------|-------------|-----------|-------------|-------------|-----------|-------------|-------------|-----------|
| | Tir.Grafito | Tir. Cuarzo | Tir. Alu. | Tir.Grafito | Tir. Cuarzo | Tir. Alu. | Tir.Grafito | Tir. Cuarzo | Tir. Alu. |
| Aliso | 78192 | 78198 | 78204 | 78210 | 78216 | 78222 | 78228 | 78234 | 78240 |
| Valenti | 78193 | 78199 | 78205 | 78211 | 78217 | 78223 | 78229 | 78235 | 78241 |
| B-ada | 78194 | 78200 | 78206 | 78212 | 78218 | 78224 | 78230 | 78236 | 78242 |
| Ceniza | 78195 | 78201 | 78207 | 78213 | 78219 | 78225 | 78231 | 78237 | 78243 |
| Avio | 78196 | 78202 | 78208 | 78214 | 78220 | 78226 | 78232 | 78238 | 78244 |
| Quarzo | 78197 | 78203 | 78209 | 78215 | 78221 | 78227 | 78233 | 78239 | 78245 |
| PVP | 321 | | | 359 | | | 432 | | |



COLUMNA REVERSIBLE

| | 120cm | | |
|------------|-------------|-------------|-----------|
| | Tir.Grafito | Tir. Cuarzo | Tir. Alu. |
| Aliso | 72062 | 72086 | 73505 |
| Valenti | 72063 | 72087 | 73506 |
| B-ada | 72064 | 72088 | 73496 |
| Ceniza | 72065 | 72089 | 73497 |
| Avio | 72066 | 72090 | 73498 |
| Quarzo | 72067 | 72091 | 73499 |
| PVP | 209 | | |

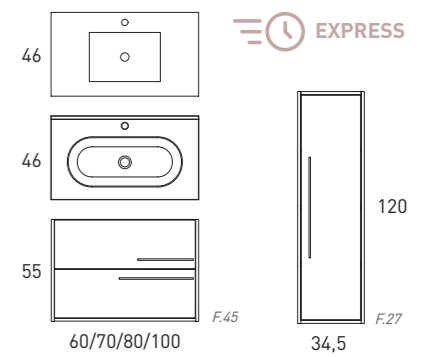

Espejo Alexa 70
Ref. 87647
P. 104

MUEBLE 80 + LAVABO FLAT
349€

■ Cajones soft close ■ Extracción parcial ■ Acabado laminado ■ Lacado Mate ■ Cajón Textil

AQUA

MUEBLE 2C + LAVABO FLAT

| | 60cm | | | 70cm | | | 80cm | | | 100cm | | |
|------------|-------------|-------------|-----------|-------------|-------------|-----------|-------------|-------------|-----------|-------------|-------------|-----------|
| | Tir.Grafito | Tir. Cuarzo | Tir. Alu. | Tir.Grafito | Tir. Cuarzo | Tir. Alu. | Tir.Grafito | Tir. Cuarzo | Tir. Alu. | Tir.Grafito | Tir. Cuarzo | Tir. Alu. |
| Aliso | 72092 | 72110 | 73875 | 78174 | 78180 | 78186 | 72098 | 72116 | 73881 | 72104 | 72122 | 73887 |
| Valenti | 72093 | 72111 | 73876 | 78175 | 78181 | 78187 | 72099 | 72117 | 73882 | 72105 | 72123 | 73888 |
| B-ada | 72094 | 72112 | 73877 | 78176 | 78182 | 78188 | 72100 | 72118 | 73883 | 72106 | 72124 | 73889 |
| Ceniza | 72095 | 72113 | 73878 | 78177 | 78183 | 78189 | 72101 | 72119 | 73884 | 72107 | 72125 | 73890 |
| Avio | 72096 | 72114 | 73879 | 78178 | 78184 | 78190 | 72102 | 72120 | 73885 | 72108 | 72126 | 73891 |
| Quarzo | 72097 | 72115 | 73880 | 78179 | 78185 | 78191 | 72103 | 72121 | 73886 | 72109 | 72127 | 73892 |
| PVP | 309 | | | 339 | | | 349 | | | 408 | | |

MUEBLE 2C + LAVABO ADA

| | 60cm | | | 80cm | | | 100cm | | |
|------------|-------------|-------------|-----------|-------------|-------------|-----------|-------------|-------------|-----------|
| | Tir.Grafito | Tir. Cuarzo | Tir. Alu. | Tir.Grafito | Tir. Cuarzo | Tir. Alu. | Tir.Grafito | Tir. Cuarzo | Tir. Alu. |
| Aliso | 78192 | 78198 | 78204 | 78210 | 78216 | 78222 | 78228 | 78234 | 78240 |
| Valenti | 78193 | 78199 | 78205 | 78211 | 78217 | 78223 | 78229 | 78235 | 78241 |
| B-ada | 78194 | 78200 | 78206 | 78212 | 78218 | 78224 | 78230 | 78236 | 78242 |
| Ceniza | 78195 | 78201 | 78207 | 78213 | 78219 | 78225 | 78231 | 78237 | 78243 |
| Avio | 78196 | 78202 | 78208 | 78214 | 78220 | 78226 | 78232 | 78238 | 78244 |
| Quarzo | 78197 | 78203 | 78209 | 78215 | 78221 | 78227 | 78233 | 78239 | 78245 |
| PVP | 321 | | | 359 | | | 432 | | |



COLUMNA REVERSIBLE

| | 120cm | | |
|------------|-------------|-------------|-----------|
| | Tir.Grafito | Tir. Cuarzo | Tir. Alu. |
| Aliso | 72062 | 72086 | 73505 |
| Valenti | 72063 | 72087 | 73506 |
| B-ada | 72064 | 72088 | 73496 |
| Ceniza | 72065 | 72089 | 73497 |
| Avio | 72066 | 72090 | 73498 |
| Quarzo | 72067 | 72091 | 73499 |
| PVP | 209 | | |

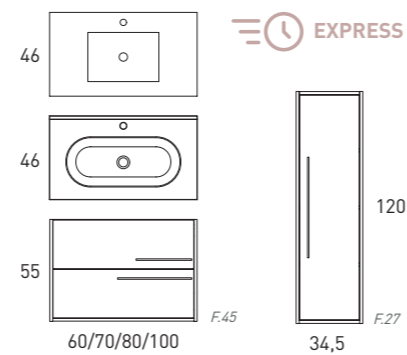

Camerino Miranda

Ref. 72337
P. 222



MUEBLE 80 + LAVABO FLAT
349€



391€
MUEBLE 80 TIR.NEGRO + LAVABO FLAT + ESP. SEVILLA

GRANADA

MUEBLE 2C + LAVABO FLAT

| | 60cm | | | 80cm | | | 100cm | | | 120cm 2 senos | | |
|------------|------------|------------|-----------|------------|------------|-----------|------------|------------|-----------|---------------|------------|-----------|
| | Tir. Alum. | Tir. Negro | Tir. Bco. | Tir. Alum. | Tir. Negro | Tir. Bco. | Tir. Alum. | Tir. Negro | Tir. Bco. | Tir. Alum. | Tir. Negro | Tir. Bco. |
| Aliso | 78246 | 78249 | 78252 | 78255 | 78258 | 78261 | 78264 | 78267 | 78270 | 78273 | 78276 | 78279 |
| Costa | 78247 | 78250 | 78253 | 78256 | 78259 | 78262 | 78265 | 78268 | 78271 | 78274 | 78277 | 78280 |
| Valenti | 78248 | 78251 | 78254 | 78257 | 78260 | 78263 | 78266 | 78269 | 78272 | 78275 | 78278 | 78281 |
| Bco-Ada | 86687 | 86643 | 86663 | 86695 | 86185 | 86671 | 86703 | 86655 | 86679 | 88148 | 88132 | 88140 |
| Ceniza | 86688 | 86644 | 86664 | 86696 | 86648 | 86672 | 86704 | 86656 | 86680 | 88149 | 88133 | 88141 |
| PVP | 308 | | | 348 | | | 422 | | | 558 | | |

MUEBLE 2C + LAVABO FLAT + ESPEJO SEVILLA

| | 60cm | | | 80cm | | | 100cm | | | 120cm 2 senos | | |
|------------|------------|------------|-----------|------------|------------|-----------|------------|------------|-----------|---------------|------------|-----------|
| | Tir. Alum. | Tir. Negro | Tir. Bco. | Tir. Alum. | Tir. Negro | Tir. Bco. | Tir. Alum. | Tir. Negro | Tir. Bco. | Tir. Alum. | Tir. Negro | Tir. Bco. |
| Aliso | 78384 | 78387 | 78390 | 78393 | 78396 | 78399 | 78402 | 78405 | 78408 | 78411 | 78414 | 78417 |
| Costa | 78385 | 78388 | 78391 | 78394 | 78397 | 78400 | 78403 | 78406 | 78409 | 78412 | 78415 | 78418 |
| Valenti | 78386 | 78389 | 78392 | 78395 | 78398 | 78401 | 78404 | 78407 | 78410 | 78413 | 78416 | 78419 |
| Bco-Ada | 86683 | 86639 | 86659 | 86691 | 86184 | 86667 | 86699 | 86651 | 86675 | 88144 | 88128 | 88136 |
| Ceniza | 86684 | 86640 | 86660 | 86692 | 86646 | 86668 | 86700 | 86652 | 86676 | 88145 | 88129 | 88137 |
| PVP | 343 | | | 391 | | | 470 | | | 656 | | |

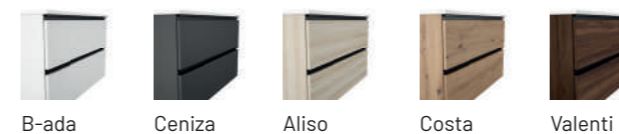

COLUMNA REVERSIBLE

| | Tirador | | |
|------------|------------|-------|--------|
| | Aluminio | Negro | Blanco |
| Aliso | 76645 | 76646 | 76647 |
| Costa | 76649 | 76650 | 76651 |
| Valenti | 76653 | 76654 | 76655 |
| Bco-Ada | 86788 | 86191 | 86792 |
| Ceniza | 86785 | 86793 | 86789 |
| PVP | 209 | | |

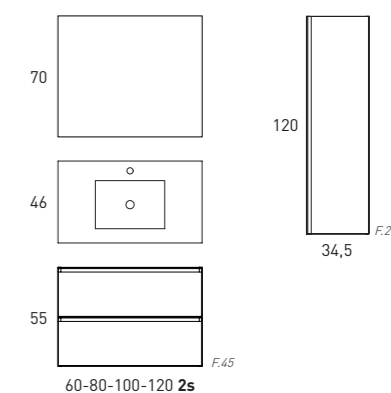

*Para conjunto con LAVABO ADA consulte pág. 45



348€
MUEBLE 80 TIR.BLANCO + LAVABO FLAT



422€
MUEBLE 100 TIR.NEGRO + LAVABO FLAT

GRANADA

MUEBLE 2C SUELO + LAVABO FLAT

| | 60cm | | | 80cm | | | 100cm | | |
|------------|------------|------------|-----------|------------|------------|-----------|------------|------------|-----------|
| | Tir. Alum. | Tir. Negro | Tir. Bco. | Tir. Alum. | Tir. Negro | Tir. Bco. | Tir. Alum. | Tir. Negro | Tir. Bco. |
| Aliso | 78420 | 78423 | 78426 | 78429 | 78432 | 78435 | 78438 | 78441 | 78444 |
| Costa | 78421 | 78424 | 78427 | 78430 | 78433 | 78436 | 78439 | 78442 | 78445 |
| Valenti | 78422 | 78425 | 78428 | 78431 | 78434 | 78437 | 78440 | 78443 | 78446 |
| Bco-Ada | 86759 | 86711 | 86735 | 86767 | 86719 | 86743 | 86775 | 86727 | 86751 |
| Ceniza | 86760 | 86712 | 86736 | 86768 | 86720 | 86744 | 86776 | 86728 | 86752 |
| PVP | 336 | | | 374 | | | 450 | | |

MUEBLE 2C SUELO + LAVABO FLAT + ESPEJO SEVILLA

| | 60cm | | | 80cm | | | 100cm | | |
|------------|------------|------------|-----------|------------|------------|-----------|------------|------------|-----------|
| | Tir. Alum. | Tir. Negro | Tir. Bco. | Tir. Alum. | Tir. Negro | Tir. Bco. | Tir. Alum. | Tir. Negro | Tir. Bco. |
| Aliso | 78492 | 78495 | 78498 | 78501 | 78504 | 78507 | 78510 | 78513 | 78516 |
| Costa | 78493 | 78496 | 78499 | 78502 | 78505 | 78508 | 78511 | 78514 | 78517 |
| Valenti | 78494 | 78497 | 78500 | 78503 | 78506 | 78509 | 78512 | 78515 | 78518 |
| Bco-Ada | 86755 | 86707 | 86731 | 86763 | 86715 | 86739 | 86771 | 86723 | 86747 |
| Ceniza | 86756 | 86708 | 86732 | 86764 | 86716 | 86740 | 86772 | 86724 | 86748 |
| PVP | 372 | | | 417 | | | 499 | | |



*Para conjunto con LAVABO ADA consulte pág. 45

COLUMNA REVERSIBLE

| | Tirador | | |
|------------|------------|-------|--------|
| | Aluminio | Negro | Blanco |
| Aliso | 76645 | 76646 | 76647 |
| Costa | 76649 | 76650 | 76651 |
| Valenti | 76653 | 76654 | 76655 |
| Bco-Ada | 86788 | 86191 | 86792 |
| Ceniza | 86785 | 86793 | 86789 |
| PVP | 209 | | |

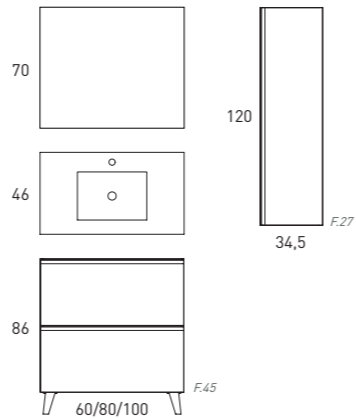

MUEBLE 100 TIR. ALUM + LAVABO FLAT
450€



374€
MUEBLE 80 TIR. NEGRO + LAVABO FLAT





Espejo Vario 80x80

Ref. 73495
P. 319

434€

MUEBLE 80 TIR.BLANCO + LAVABO FLAT

GRANADA

MUEBLE 3C + LAVABO FLAT

| | 60cm | | | 80cm | | | 100cm | | |
|------------|------------|------------|-----------|------------|------------|-----------|------------|------------|-----------|
| | Tir. Alum. | Tir. Negro | Tir. Bco. | Tir. Alum. | Tir. Negro | Tir. Bco. | Tir. Alum. | Tir. Negro | Tir. Bco. |
| Aliso | 78519 | 78522 | 78525 | 78528 | 78531 | 78534 | 78537 | 78540 | 78543 |
| Costa | 78520 | 78523 | 78526 | 78529 | 78532 | 78535 | 78538 | 78541 | 78544 |
| Valenti | 78521 | 78524 | 78527 | 78530 | 78533 | 78536 | 78539 | 78542 | 78545 |
| Bco-Ada | 70556 | 70568 | 70580 | 70560 | 70572 | 70584 | 70564 | 70576 | 70588 |
| Ceniza | 70557 | 70569 | 70581 | 70561 | 70573 | 70585 | 70565 | 70577 | 70589 |
| PVP | 379 | | | 434 | | | 507 | | |

MUEBLE 3C + LAVABO FLAT + ESPEJO SEVILLA

| | 60cm | | | 80cm | | | 100cm | | |
|------------|------------|------------|-----------|------------|------------|-----------|------------|------------|-----------|
| | Tir. Alum. | Tir. Negro | Tir. Bco. | Tir. Alum. | Tir. Negro | Tir. Bco. | Tir. Alum. | Tir. Negro | Tir. Bco. |
| Aliso | 78591 | 78594 | 78597 | 78600 | 78603 | 78606 | 78609 | 78612 | 78615 |
| Costa | 78592 | 78595 | 78598 | 78601 | 78604 | 78607 | 78610 | 78613 | 78616 |
| Valenti | 78593 | 78596 | 78599 | 78602 | 78605 | 78608 | 78611 | 78614 | 78617 |
| Bco-Ada | 70592 | 70604 | 70616 | 70596 | 70608 | 70620 | 70600 | 70612 | 70624 |
| Ceniza | 70593 | 70605 | 70617 | 70597 | 70609 | 70621 | 70601 | 70613 | 70625 |
| PVP | 415 | | | 477 | | | 555 | | |



B-ada Ceniza Aliso Costa Valenti

*Para conjunto con LAVABO ADA consulte pág. 45

COLUMNA REVERSIBLE

| | Tirador | | |
|------------|------------|-------|--------|
| | Aluminio | Negro | Blanco |
| Aliso | 76645 | 76646 | 76647 |
| Costa | 76649 | 76650 | 76651 |
| Valenti | 76653 | 76654 | 76655 |
| Bco-Ada | 86788 | 86191 | 86792 |
| Ceniza | 86785 | 86793 | 86789 |
| PVP | 209 | | |

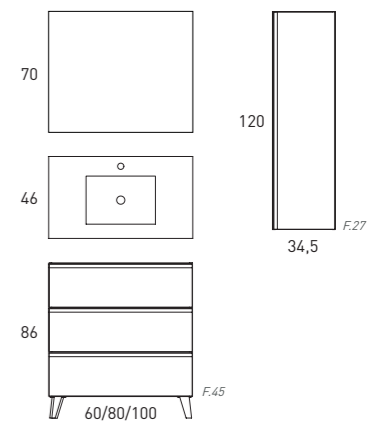

434€

MB 80 TIR.NEGRO + LAVABO FLAT

KYOTO

MUEBLE + LAVABO FLAT

| Acabado | 60cm | 80cm | 100cm | 120cm 2s |
|-------------|------------|------------|------------|------------|
| Blanco-Ada | 78126 | 78127 | 78128 | 78129 |
| Ceniza | 78130 | 78131 | 78132 | 78133 |
| Cotton | 78134 | 78135 | 78136 | 78137 |
| Avio | 78138 | 78139 | 78140 | 78141 |
| Valenti | 78142 | 78143 | 78144 | 78145 |
| Roble Costa | 78146 | 78147 | 78148 | 78149 |
| PVP | 416 | 471 | 542 | 712 |

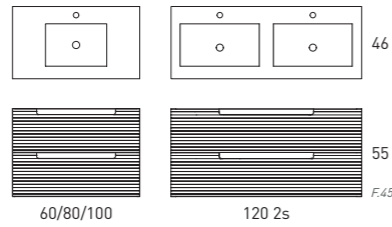

COLUMNA REVERSIBLE

| Acabado | Ref. |
|-------------|------------|
| Blanco-Ada | 77464 |
| Ceniza | 77470 |
| Cotton | 77465 |
| Avio | 77468 |
| Valenti | 77474 |
| Roble Costa | 77473 |
| PVP | 240 |

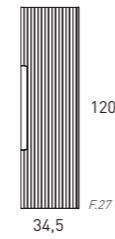

MUEBLE + LAVABO ADA

| Acabado | 60cm | 80cm | 100cm | 120cm 2s |
|-------------|------------|------------|------------|------------|
| Blanco-Ada | 78150 | 78151 | 78152 | 78153 |
| Ceniza | 78154 | 78155 | 78156 | 78157 |
| Cotton | 78158 | 78159 | 78160 | 78161 |
| Avio | 78162 | 78163 | 78164 | 78165 |
| Valenti | 78166 | 78167 | 78168 | 78169 |
| Roble Costa | 78170 | 78171 | 78172 | 78173 |
| PVP | 425 | 480 | 563 | 726 |

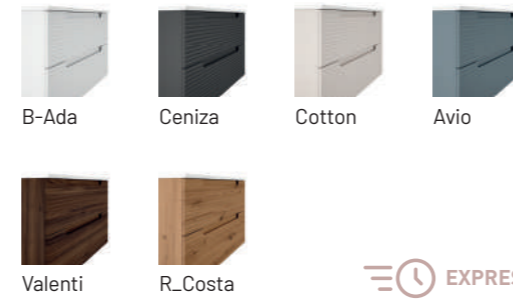
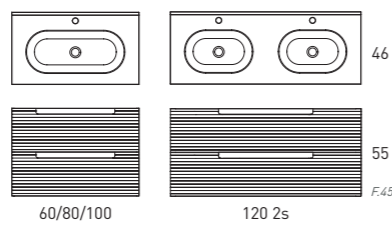

Cajones soft close
 Extracción total
 Lacado Mate
 Cajón metálico
 Laminado 3D





Espejo Lune Led
Ref. 71971
P. 203

MUEBLE 120 + LAVABO FLAT
712€

KYOTO

MUEBLE + LAVABO FLAT

| Acabado | 60cm | 80cm | 100cm | 120cm 2s |
|-------------|------------|------------|------------|------------|
| Blanco-Ada | 78126 | 78127 | 78128 | 78129 |
| Ceniza | 78130 | 78131 | 78132 | 78133 |
| Cotton | 78134 | 78135 | 78136 | 78137 |
| Avio | 78138 | 78139 | 78140 | 78141 |
| Valenti | 78142 | 78143 | 78144 | 78145 |
| Roble Costa | 78146 | 78147 | 78148 | 78149 |
| PVP | 416 | 471 | 542 | 712 |

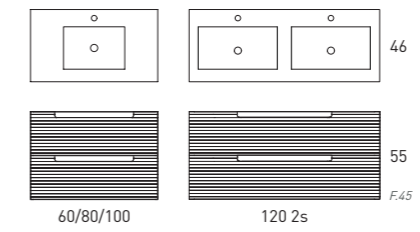

MUEBLE + LAVABO ADA

| Acabado | 60cm | 80cm | 100cm | 120cm 2s |
|-------------|------------|------------|------------|------------|
| Blanco-Ada | 78150 | 78151 | 78152 | 78153 |
| Ceniza | 78154 | 78155 | 78156 | 78157 |
| Cotton | 78158 | 78159 | 78160 | 78161 |
| Avio | 78162 | 78163 | 78164 | 78165 |
| Valenti | 78166 | 78167 | 78168 | 78169 |
| Roble Costa | 78170 | 78171 | 78172 | 78173 |
| PVP | 425 | 480 | 563 | 726 |

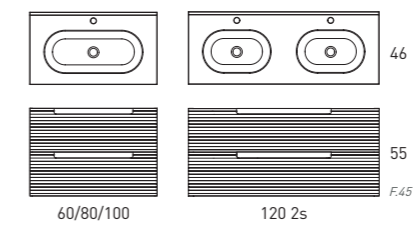

COLUMNA REVERSIBLE

| Acabado | Ref. |
|-------------|------------|
| Blanco-Ada | 77464 |
| Ceniza | 77470 |
| Cotton | 77465 |
| Avio | 77468 |
| Valenti | 77474 |
| Roble Costa | 77473 |
| PVP | 240 |

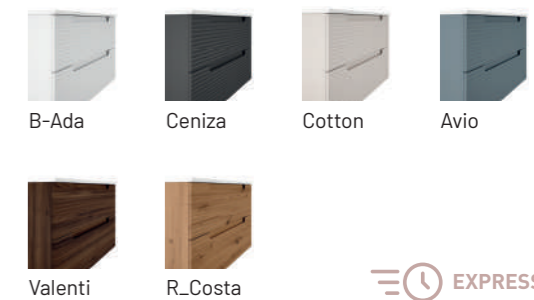
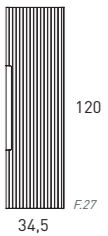

MUEBLE 60 + LAVABO FLAT
416€



- Cajones soft close
- Extracción total
- Lacado Mate
- Cajón metálico
- Laminado 3D



Espejo Liss 50 Led
Ref. 72206
P. 144

502€
MUEBLE 100 DER + LAVABO FLAT

BOX

MUEBLE 2CAJ/IPTA + LAVABO FLAT

| Acabado | 80 izq. | 80 der. | 90 izq. | 90 der. | 100 izq. | 100 der. |
|------------|------------|------------|------------|------------|------------|------------|
| B-ada | 78750 | 78754 | 78758 | 78762 | 78766 | 78770 |
| Ceniza | 78751 | 78755 | 78759 | 78763 | 78767 | 78771 |
| PVP | 475 | 475 | 523 | 523 | 590 | 590 |
| Abedul | 86797 | 86801 | 84985 | 84981 | 86805 | 86809 |
| Aliso | 78752 | 78756 | 78760 | 78764 | 78768 | 78772 |
| Costa | 78753 | 78757 | 78761 | 78765 | 78769 | 78773 |
| Valenti | 89313 | 89314 | 89315 | 89316 | 89317 | 89318 |
| Nieve Br. | 86796 | 86800 | 83427 | 83419 | 86804 | 86808 |
| PVP | 388 | 388 | 469 | 469 | 502 | 502 |

MUEBLE 2CAJ/IPTA + LAV FLAT + ESP SEVILLA

| Acabado | 80 izq. | 80 der. | 90 izq. | 90 der. | 100 izq. | 100 der. |
|------------|------------|------------|------------|------------|------------|------------|
| B-ada | 78774 | 78778 | 78782 | 78786 | 78790 | 78794 |
| Ceniza | 78775 | 78779 | 78783 | 78787 | 78791 | 78795 |
| PVP | 521 | 521 | 579 | 579 | 649 | 649 |
| Abedul | 86813 | 86817 | 84983 | 84979 | 86821 | 86825 |
| Aliso | 78776 | 78780 | 78784 | 78788 | 78792 | 78796 |
| Costa | 78777 | 78781 | 78785 | 78789 | 78793 | 78797 |
| Valenti | 89319 | 89320 | 89321 | 89322 | 89323 | 89324 |
| Nieve Br. | 86812 | 86816 | 83423 | 83415 | 86820 | 86824 |
| PVP | 426 | 426 | 509 | 509 | 544 | 544 |

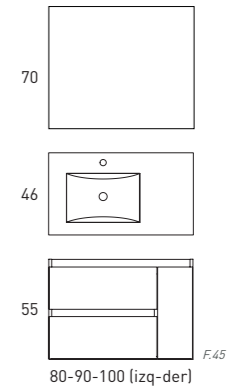

*Izquierda / Derecha hace referencia a la poza del lavabo.

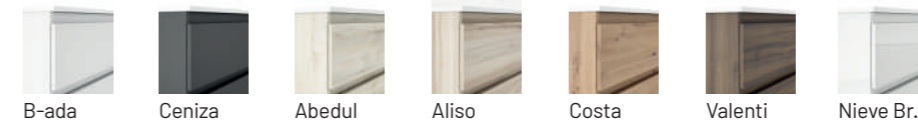

579€
MB 90 IZQ + LAV FLAT + ESP SEVILLA

Cierre soft close
 Extracción parcial
 Acabado laminado
 Alto brillo
 Lacado mate
 Cajón Textil

BOX

MUEBLE 2C + LAVABO FLAT - Fondo 45

| Acabado | 60cm | 70cm | 80cm | 100cm | 120cm 2S |
|------------|------------|------------|------------|------------|------------|
| B-ada | 78666 | 78670 | 78674 | 78678 | 78682 |
| Ceniza | 78667 | 78671 | 78675 | 78679 | 78683 |
| PVP | 297 | 329 | 339 | 399 | 559 |
| Abedul | 84953 | 84957 | 84961 | 84965 | 84977 |
| Aliso | 78668 | 78672 | 78676 | 78680 | 78684 |
| Costa | 78669 | 78673 | 78677 | 78681 | 78685 |
| Valenti | 88359 | 88360 | 88361 | 88362 | 88363 |
| Nieve Br. | 83375 | 83383 | 83387 | 83391 | 85279 |
| PVP | 276 | 302 | 309 | 373 | 541 |

Fondo Reducido 40

| Acabado | 60 red. | 80 red. |
|------------|------------|------------|
| B-ada | 78686 | 78690 |
| Ceniza | 78687 | 78691 |
| PVP | 297 | 339 |
| Abedul | 84969 | 84973 |
| Aliso | 78688 | 78692 |
| Costa | 78689 | 78693 |
| Valenti | 89333 | 89334 |
| Nieve Br. | 83399 | 83407 |
| PVP | 276 | 309 |

AUXILIAR

| Acabado | Columna | Colgar |
|------------|------------|------------|
| B-ada | 77443 | 77450 |
| Ceniza | 77447 | 77454 |
| PVP | 199 | 139 |
| Abedul | 84488 | 84492 |
| Aliso | 77448 | 77455 |
| Costa | 77449 | 77456 |
| Valenti | 88374 | 88375 |
| Nieve Br. | 82323 | 82328 |
| PVP | 189 | 125 |

MUEBLE 2C + LAV FLAT + ESP SEVILLA - Fondo 45

| Acabado | 60cm | 70cm | 80cm | 100cm | 120cm 2S |
|------------|------------|------------|------------|------------|------------|
| B-ada | 78694 | 78698 | 78702 | 78706 | 78710 |
| Ceniza | 78695 | 78699 | 78703 | 78707 | 78711 |
| PVP | 338 | 372 | 386 | 458 | 632 |
| Abedul | 84951 | 84955 | 84959 | 84963 | 84975 |
| Aliso | 78696 | 78700 | 78704 | 78708 | 78712 |
| Costa | 78697 | 78701 | 78705 | 78709 | 78713 |
| Valenti | 88364 | 88365 | 88366 | 88367 | 88368 |
| Nieve Br. | 82883 | 83379 | 82886 | 82889 | 85277 |
| PVP | 312 | 341 | 351 | 421 | 615 |

Fondo Reducido 40

| Acabado | 60 red. | 80 red. |
|------------|------------|------------|
| B-ada | 78714 | 78718 |
| Ceniza | 78715 | 78719 |
| PVP | 338 | 386 |
| Abedul | 84967 | 84971 |
| Aliso | 78716 | 78720 |
| Costa | 78717 | 78721 |
| Valenti | 89335 | 89336 |
| Nieve Br. | 83395 | 83403 |
| PVP | 312 | 351 |

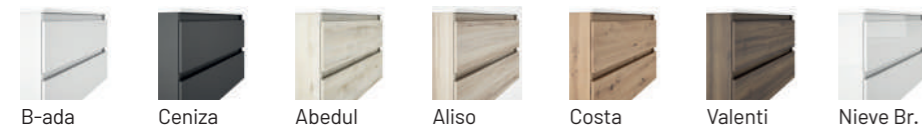
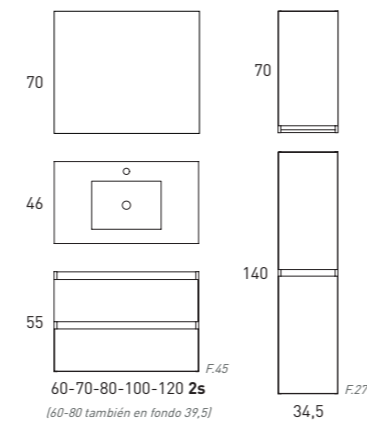

*Para conjunto con LAVABO ADA consulte pág. 45



MUEBLE 60 + LAV. FLAT



MUEBLE 100 + LAV. FLAT



351€
MUEBLE 80 + LAVABO FLAT + ESPEJO SEVILLA



432€
MUEBLE 80 + LAVABO FLAT + ESPEJO SEVILLA

BOX

EXPRESS

MUEBLE 3C + LAVABO FLAT - Fondo 45

| Acabado | 60cm | 70cm | 80cm | 100cm | 120cm 2S |
|------------|------------|------------|------------|------------|------------|
| B-ada | 78798 | 78802 | 78809 | 78813 | 78817 |
| Ceniza | 78799 | 78803 | 78810 | 78814 | 78818 |
| PVP | 359 | 399 | 416 | 488 | 808 |
| Abedul | 84921 | 78804 | 84925 | 84929 | 84941 |
| Aliso | 78800 | 78805 | 78811 | 78815 | 78819 |
| Costa | 78801 | 78806 | 78812 | 78816 | 78820 |
| Valenti | 89325 | 78807 | 89326 | 89327 | 89328 |
| Nieve Br. | 83327 | 78808 | 83331 | 83335 | 83359 |
| PVP | 343 | 377 | 389 | 461 | 765 |

Fondo Reducido 40

| 60 red. | 80 red. |
|------------|------------|
| 78821 | 78825 |
| 78822 | 78826 |
| 359 | 416 |
| 84933 | 84937 |
| 78823 | 78827 |
| 78824 | 78828 |
| 89337 | 89338 |
| 83343 | 83351 |
| 343 | 389 |

AUXILIAR

| Acabado | Columna | Colgar |
|------------|------------|------------|
| B-ada | 77443 | 77450 |
| Ceniza | 77447 | 77454 |
| PVP | 199 | 139 |
| Abedul | 84488 | 84492 |
| Aliso | 77448 | 77455 |
| Costa | 77449 | 77456 |
| Valenti | 88374 | 88375 |
| Nieve Br. | 82323 | 82328 |
| PVP | 189 | 125 |

MUEBLE 3C+ LAV FLAT + ESP SEVILLA - Fondo 45

| Acabado | 60cm | 70cm | 80cm | 100cm | 120cm 2S |
|------------|------------|------------|------------|------------|------------|
| B-ada | 78829 | 78833 | 78840 | 78844 | 78848 |
| Ceniza | 78830 | 78834 | 78841 | 78845 | 78849 |
| PVP | 399 | 443 | 462 | 547 | 885 |
| Abedul | 84919 | 78835 | 84923 | 84927 | 84939 |
| Aliso | 78831 | 78836 | 78842 | 78846 | 78850 |
| Costa | 78832 | 78837 | 78843 | 78847 | 78851 |
| Valenti | 89329 | 78838 | 89330 | 89331 | 89332 |
| Nieve Br. | 82895 | 78839 | 82898 | 82901 | 83355 |
| PVP | 379 | 422 | 432 | 509 | 860 |

Fondo Reducido 40

| 60 red. | 80 red. |
|------------|------------|
| 78852 | 78856 |
| 78853 | 78857 |
| 399 | 462 |
| 84931 | 84395 |
| 78854 | 78858 |
| 78855 | 78859 |
| 89339 | 89340 |
| 83339 | 83347 |
| 379 | 432 |

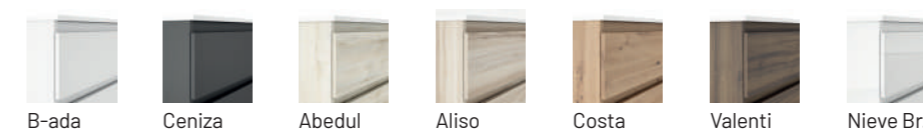
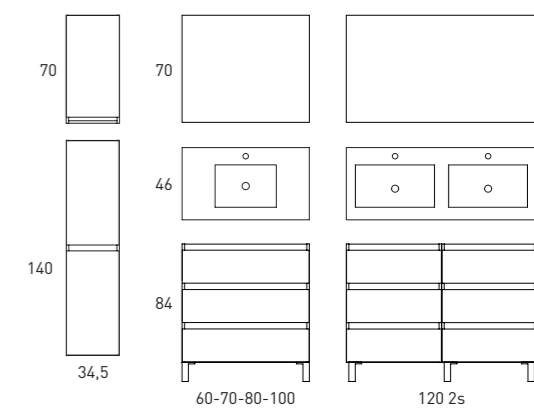

*Para conjunto con LAVABO ADA consulte pág. 45



416€
MUEBLE 80 + LAVABO FLAT

Cierre soft close Extracción parcial Acabado laminado Alto brillo Lacado mate Cajón Textil

ELEVEN

MUEBLE 1 CAJON + LAVABO FLAT

| Acabado | 60cm | 80cm | 100cm | 120cm 2s |
|------------|------------|------------|------------|------------|
| Blanco-Ada | 71314 | 71319 | 71324 | 71329 |
| Ceniza | 71315 | 71320 | 71325 | 71330 |
| Avio | 71316 | 71321 | 71326 | 71331 |
| Valenti | 71317 | 71322 | 71327 | 71332 |
| Aliso | 78618 | 78619 | 78620 | 78621 |
| PVP | 231 | 247 | 309 | 553 |

MUEBLE 1 CAJON + LAVABO ADA

| Acabado | 60cm | 80cm | 100cm | 120cm 2s |
|------------|------------|------------|------------|------------|
| Blanco-Ada | 78622 | 78627 | 78632 | 78637 |
| Ceniza | 78623 | 78628 | 78633 | 78638 |
| Avio | 78624 | 78629 | 78634 | 78639 |
| Valenti | 78625 | 78630 | 78635 | 78640 |
| Aliso | 78626 | 78631 | 78636 | 78641 |
| PVP | 251 | 287 | 354 | 587 |

COLUMNA REVERSIBLE

| Acabado | Ref. |
|------------|------------|
| Blanco-Ada | 85656 |
| Ceniza | 85657 |
| Avio | 85658 |
| Valenti | 85659 |
| Aliso | 76093 |
| PVP | 209 |

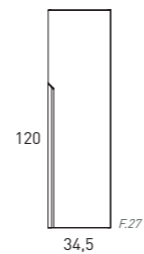

MUEBLE 1 CAJON/ 1 HUECO + LAVABO FLAT

| Acabado | 60cm | 80cm | 100cm | 120cm 2s |
|------------|------------|------------|------------|------------|
| Blanco-Ada | 85616 | 85621 | 85626 | 85631 |
| Ceniza | 85617 | 85622 | 85627 | 85632 |
| Avio | 85618 | 85623 | 85628 | 85633 |
| Valenti | 85619 | 85624 | 85629 | 85634 |
| Aliso | 78642 | 78643 | 78644 | 78645 |
| PVP | 250 | 275 | 342 | 581 |

MUEBLE 1 CAJON/1 HUECO + LAVABO ADA

| Acabado | 60cm | 80cm | 100cm | 120cm 2s |
|------------|------------|------------|------------|------------|
| Blanco-Ada | 78646 | 78651 | 78656 | 78661 |
| Ceniza | 78647 | 78652 | 78657 | 78662 |
| Avio | 78648 | 78653 | 78658 | 78663 |
| Valenti | 78649 | 78654 | 78659 | 78664 |
| Aliso | 78650 | 78655 | 78660 | 78665 |
| PVP | 278 | 315 | 387 | 646 |

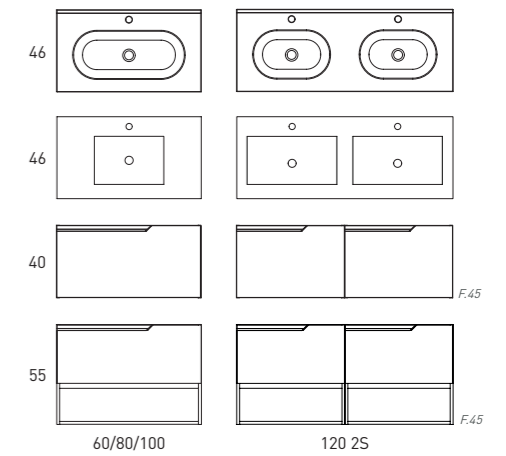



MUEBLE 80 + LAVABO ADA
475€

ARCO

MUEBLE + LAVABO FLAT

| Acabado | 60cm | 80cm | 100cm | 120cm 2s |
|------------|------------|------------|------------|------------|
| Blanco-Ada | 78888 | 78892 | 78896 | 78900 |
| Musgo | 78889 | 78893 | 78897 | 78901 |
| Avio | 78890 | 78894 | 78898 | 78902 |
| Ceniza | 78891 | 78895 | 78899 | 78903 |
| PVP | 427 | 466 | 542 | 729 |

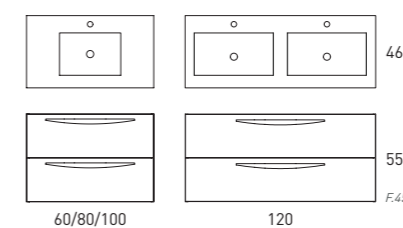

COLUMNA REVERSIBLE

| Acabado | Ref. |
|------------|------------|
| Blanco-Ada | 77475 |
| Musgo | 77478 |
| Avio | 77479 |
| Ceniza | 77481 |
| PVP | 226 |

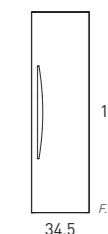

MUEBLE + LAVABO ADA

| Acabado | 60cm | 80cm | 100cm | 120cm 2s |
|------------|------------|------------|------------|------------|
| Blanco-Ada | 78904 | 78908 | 78912 | 78916 |
| Musgo | 78905 | 78909 | 78913 | 78917 |
| Avio | 78906 | 78910 | 78914 | 78918 |
| Ceniza | 78907 | 78911 | 78915 | 78919 |
| PVP | 435 | 475 | 563 | 741 |

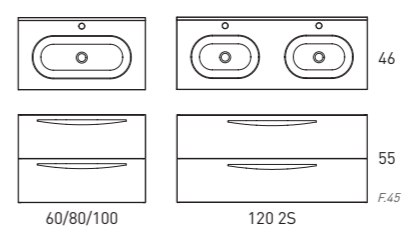



Espejo Ada Led

Ref. 87218

P. 177



MUEBLE 60 + LAVABO FLAT

359€



VISION



MUEBLE + LAVABO FLAT

| Acabado | 60cm | 80cm | 100cm | 120cm 2s |
|-------------------|------------|------------|------------|------------|
| Abedul - Tórtora | 83847 | 83848 | 83849 | 83850 |
| Costa - Blanco | 78920 | 78921 | 78922 | 78923 |
| Valenti - Negro | 71295 | 71296 | 71297 | 71298 |
| Nieve Br - Blanco | 83839 | 83840 | 83841 | 83842 |
| Gris Br - Blanco | 83855 | 83856 | 83857 | 83858 |
| PVP | 359 | 403 | 482 | 639 |

MUEBLE + LAVABO ADA

| Acabado | 60cm | 80cm | 100cm | 120cm 2s |
|-------------------|------------|------------|------------|------------|
| Abedul - Tórtora | 78928 | 78932 | 78936 | 78940 |
| Costa - Blanco | 78929 | 78933 | 78937 | 78941 |
| Valenti - Negro | 78930 | 78934 | 78938 | 78942 |
| Nieve Br - Blanco | 78931 | 78935 | 78939 | 78943 |
| Gris Br - Blanco | 78951 | 78952 | 78953 | 78954 |
| PVP | 371 | 415 | 495 | 669 |

MUEBLE + LAV FLAT + ESP VISION

| Acabado | 60cm | 80cm | 100cm | 120cm 2s |
|-------------------|------------|------------|------------|------------|
| Abedul - Tórtora | 83843 | 83844 | 83845 | 83846 |
| Costa - Blanco | 78924 | 78925 | 78926 | 78927 |
| Valenti - Negro | 71299 | 71300 | 71301 | 71302 |
| Nieve Br - Blanco | 83835 | 83836 | 83837 | 83838 |
| Gris Br - Blanco | 83851 | 83852 | 83853 | 83854 |
| PVP | 428 | 481 | 573 | 763 |

COLUMNA / COLGAR REVERSIBLE

| Acabado | Columna | Colgar |
|-------------------|------------|------------|
| Abedul - Tórtora | 83122 | 83129 |
| Costa - Blanco | 76536 | 76540 |
| Valenti - Negro | 70336 | 70337 |
| Nieve Br - Blanco | 83119 | 83126 |
| Gris Br - Blanco | 78955 | 78956 |
| PVP | 202 | 153 |

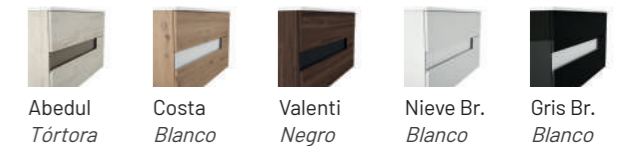
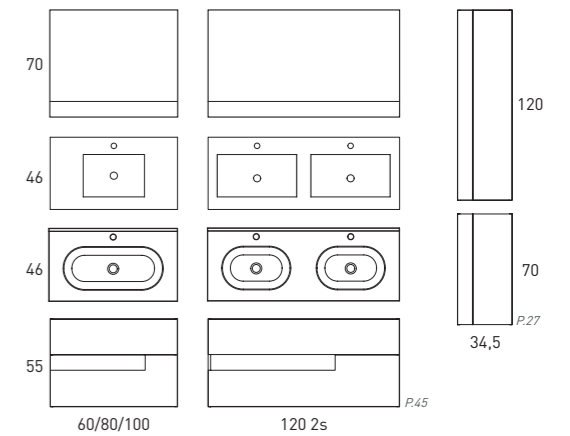

481€

MUEBLE 80 + LAVABO FLAT + ESP. VISION

NOMAD

ENCIMERA NOMAD 10CM

| Acabado | 60cm | 80cm | 100cm | 120cm |
|------------|------------|------------|------------|------------|
| Costa | 76155 | 76156 | 76157 | 76158 |
| Cala | 70981 | 70982 | 70983 | 70984 |
| Harlem | 70989 | 70990 | 70991 | 70992 |
| PVP | 125 | 137 | 164 | 175 |

*Consultar encimeras a medida en catálogo 6.0

REALIZACIÓN DE TALADROS EN ENCIMERA

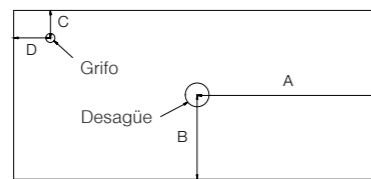

Indique las dimensiones y el diámetro del desagüe y del grifo en milímetros. La empresa no es responsable de la definición incorrecta de las medidas. No se aceptan devoluciones por este motivo.

PVP 29

MUEBLE NOMAD 1C

| Acabado | 60cm | 80cm | 100cm | 120cm |
|------------|------------|------------|------------|------------|
| Costa | 77528 | 77529 | 77530 | 77531 |
| Cala | 77520 | 77521 | 77522 | 77523 |
| Harlem | 77524 | 77525 | 77526 | 77527 |
| B-ada | 77484 | 77485 | 77486 | 77487 |
| Ceniza | 77508 | 77509 | 77510 | 77511 |
| PVP | 253 | 280 | 322 | 356 |

LAVABOS SOBREPONER

Cerámico



COLORS
B-brillo 70310 **109**
B-ada 87434 **181**

Solid surface



ASSEN
70311 **218**



ARTIC
70313 **225**



QUADRO
70312 **238**



Aplique Voile 70cm (2ud)

Ref. 2 x 76675
P. 2 x 62



MUEBLE 80 + ENCIMERA 80
417€



Descubre más posibilidades en nuestro catálogo 6.0



MUEBLE 50 1C/1P + TAPA
250€

MIDI

MUEBLE 2C SUSPENDIDO + LAVABO MIDI

| Acabado | Tirador negro | | Tirador cromo | |
|------------|---------------|------------|---------------|------------|
| | 50cm | 60cm | 50cm | 60cm |
| Aliso | 73898 | 73902 | 73906 | 73910 |
| Valenti | 73899 | 73903 | 73907 | 73911 |
| B-ada | 73900 | 73904 | 73908 | 73912 |
| Ceniza | 73901 | 73905 | 73909 | 73913 |
| PVP | 332 | 351 | 332 | 351 |

MUEBLE A SUELO + LAVABO MIDI

| Acabado | Tirador negro | | Tirador cromo | |
|------------|---------------|------------|---------------|------------|
| | 50 1C 1P | 60 1C 2P | 50 1C 1P | 60 1C 2P |
| Aliso | 73914 | 73918 | 73922 | 73926 |
| Valenti | 73915 | 73919 | 73923 | 73927 |
| B-ada | 73916 | 73920 | 73924 | 73928 |
| Ceniza | 73917 | 73921 | 73925 | 73929 |
| PVP | 353 | 390 | 353 | 390 |

MUEBLE 2C SUSPENDIDO + TAPA

| Acabado | Tirador negro | | Tirador cromo | |
|------------|---------------|------------|---------------|------------|
| | 50cm | 60cm | 50cm | 60cm |
| Aliso | 73930 | 73934 | 73938 | 73942 |
| Valenti | 73931 | 73935 | 73939 | 73943 |
| PVP | 228 | 257 | 228 | 257 |
| B-ada | 73932 | 73936 | 73940 | 73944 |
| Ceniza | 73933 | 73937 | 73941 | 73945 |
| PVP | 267 | 296 | 267 | 296 |

MUEBLE A SUELO + TAPA

| Acabado | Tirador negro | | Tirador cromo | |
|------------|---------------|------------|---------------|------------|
| | 50 1C 1P | 60 1C 2P | 50 1C 1P | 60 1C 2P |
| Aliso | 73946 | 73950 | 73954 | 73958 |
| Valenti | 73947 | 73951 | 73955 | 73959 |
| PVP | 250 | 296 | 250 | 296 |
| B-ada | 73948 | 73952 | 73956 | 73960 |
| Ceniza | 73949 | 73953 | 73957 | 73961 |
| PVP | 288 | 334 | 288 | 334 |

*Tapa Aliso y Valenti modelo Idole / Tapa B-ada y Ceniza modelo Comptech.

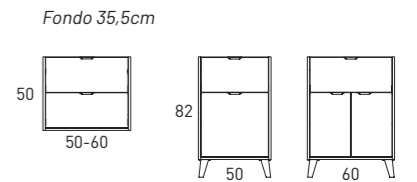

LAVABO PETIT

Lavabo cerámico

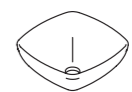

Petit 30x30 cm
Ref. 73467
P. 97



Petit round 320 cm
Ref. 73468
P. 107



MUEBLE 60 1C/2P + LAV. MIDI
390€



MUEBLE 50 SUSP + LAV. MIDI
332€

Cierre soft close Extracción total Lacado Mate Acabado laminado Cajón Textil

LAGOS 40

MUEBLE 40 + LAVABO + ESPEJO

| Acabado | 40cm |
|--------------------|-------|
| Costa - Tir. Negro | 76711 |
| Aliso - Tir. Negro | 70821 |
| B-ada | 88105 |
| Musgo | 88118 |
| Avio | 88119 |
| Ceniza | 88106 |
| PVP | 232 |

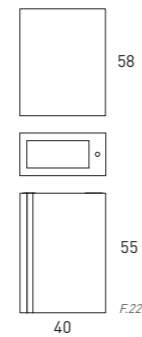

Puerta soft close
 Acabado laminado
 Lacado Mate
 Reversible
 Lavabo acrílico

LAGOS 50

MUEBLE 2 PUERTAS + LAVABO

| Acabado | 50cm |
|--------------------|-------|
| Aliso - Tir. Negro | 72182 |
| B-ada | 72183 |
| Ceniza | 72184 |
| PVP | 199 |

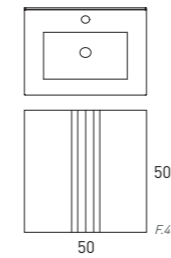

MUEBLE 2 CAJONES + LAVABO

| Acabado | 50cm |
|--------------------|-------|
| Aliso - Tir. Negro | 72185 |
| B-ada | 72186 |
| Ceniza | 72187 |
| PVP | 269 |

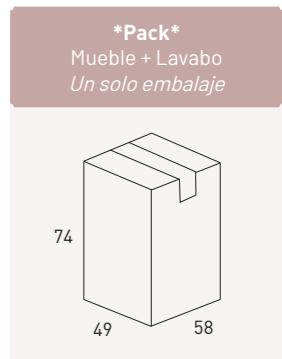
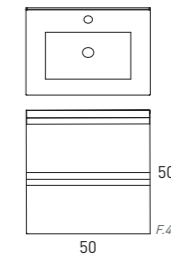

Cierre soft close
 Extracción parcial
 Acabado laminado
 Lacado Mate
 Cajón Textil
 Lavabo cerámico

LOFT

Pack
Mueble, Lavabo y Espejo
Un solo embalaje

MUEBLE 40 + LAVABO + ESPEJO

| | |
|----------------|-------------|
| Acabado | 40cm |
| Costa | 78944 |
| B-ada | 88114 |
| Ceniza | 88115 |
| PVP | 189 |

EXPRESS

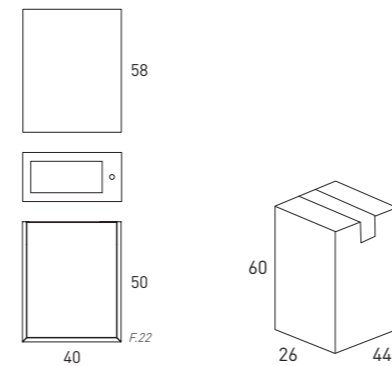

Acabado laminado Lacado Mate Reversible Lavabo acrílico Sistema Push

COLUMNA BASIC

REVERSIBLE Y COMBINABLE
CON TODAS LAS COLECCIONES

COLUMNA BASIC SUSPENDIDA

- B-ada 73827
- Cotton 73831
- Griggio 73832
- Musgo 73830
- Avio 73829
- Quarzo 73833
- Ceniza 73828
- Navy 73834
- Black 73835
- Abedul 73826
- Aliso 73823
- Costa 76189
- Valenti 73822
- Nieve Brillo 73837
- Gris Brillo 73838

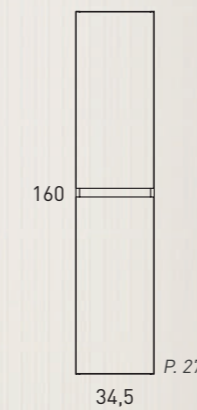

P. 216

PATAS COMPATIBLES

- Box cromo (x4) 73840
- Granada alu (x4) 73477
- Granada black (x4) 73478
- Granada blanco (x4) 73479

P. 13





Para opción a suelo, especificar código de las patas.



ARMARIO ESPEJO

MIRANDA

ACABADOS EN SINTONÍA CON TU MUEBLE BAÑO

| Alto 63cm Prof 16cm |  60 2P |  80 2P |  100 3P |  120 3P |
|------------------------|---|---|--|--|
| ○ b-ada | 71973 | 71989 | 72005 | 72021 |
| ● cotton | 73454 | 73455 | 73456 | 73457 |
| ● griggio | 71978 | 71994 | 72010 | 72026 |
| ● musgo | 71976 | 71992 | 72008 | 72024 |
| ● avio | 71975 | 71991 | 72007 | 72023 |
| ● quarzo | 71977 | 71993 | 72009 | 72025 |
| ● ceniza | 71974 | 71990 | 72006 | 72022 |
| ● navy | 71979 | 71995 | 72011 | 72027 |
| ● black | 71980 | 71996 | 72012 | 72028 |
| ● abedul | 71981 | 71997 | 72013 | 72029 |
| ● aliso | 72336 | 72337 | 72338 | 72339 |
| ● costa | 76030 | 76031 | 76032 | 76033 |
| ● valenti | 71984 | 72000 | 72016 | 72032 |
| ● nieve br. | 71986 | 72002 | 72018 | 72034 |
| ● gris osc. br | 71987 | 72003 | 72019 | 72035 |
| | 211 | 222 | 278 | 302 |



*Complétalo con el aplique Miranda



Accesorio enchufe Miranda

Podrás instalarlo en el Camerino Miranda

| Ref. | PVP |
|-------|-----------|
| 74916 | 30 |

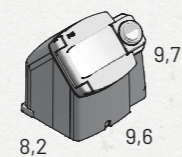

ESPEJOS

SEVILLA



| | | |
|------------|-------|-----------|
| 50 x 70cm | 72207 | 40 |
| 60 x 70cm | 80063 | 43 |
| 70 x 70cm | 85114 | 47 |
| 80 x 70cm | 80064 | 48 |
| 90 x 70cm | 83705 | 61 |
| 100 x 70cm | 80265 | 62 |
| 120 x 70cm | 80267 | 76 |

ELDA



| | | |
|------------|-------|------------|
| 60 x 70cm | 83016 | 62 |
| 70 x 70cm | 84586 | 69 |
| 80 x 70cm | 83017 | 78 |
| 100 x 70cm | 83018 | 90 |
| 120 x 70cm | 83019 | 106 |

PANDO



| | | |
|------------|-------|-----------|
| 60 x 70cm | 80221 | 43 |
| 80 x 70cm | 80223 | 51 |
| 100 x 70cm | 80225 | 61 |
| 120 x 70cm | 80226 | 66 |

ADA

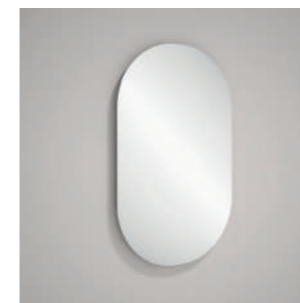

| | | |
|-----------|-------|-----------|
| 50 x 80cm | 89358 | 67 |
|-----------|-------|-----------|

LUNE



| | | |
|------------|-------|-----------|
| 50 x 120cm | 71970 | 79 |
|------------|-------|-----------|

LOIRA



| | | |
|----------------|-------|------------|
| ● 50x80 negro | 87650 | 99 |
| ○ 50x80 blanco | 87651 | 99 |
| ● 50x80 dorado | 73489 | 111 |

LISS



| | | |
|---------|-------|-----------|
| 50 Ø cm | 72205 | 58 |
| 70 Ø cm | 85109 | 67 |
| 80 Ø cm | 70314 | 77 |
| 90 Ø cm | 87215 | 81 |

ALEXA



| | | |
|----------------|-------|------------|
| ● 70Øcm negro | 87647 | 104 |
| ○ 70Øcm blanco | 87646 | 104 |
| ● 70Øcm dorado | 73483 | 114 |
| ● 80Øcm negro | 73117 | 127 |
| ○ 80Øcm blanco | 73116 | 127 |
| ● 80Øcm dorado | 74917 | 140 |
| ● 90Øcm negro | 87649 | 131 |
| ○ 90Øcm blanco | 87648 | 131 |
| ● 90Øcm dorado | 73484 | 145 |

CAPRI



| | | |
|-----------------|-------|------------|
| ○ 60x80 b-ada | 87660 | 109 |
| ● 60x80 cotton | 87664 | 109 |
| ● 60x80 griggio | 70316 | 109 |
| ● 60x80 musgo | 87665 | 109 |
| ● 60x80 avio | 87663 | 109 |
| ● 60x80 quarzo | 76190 | 109 |
| ● 60x80 ceniza | 87662 | 109 |
| ● 60x80 navy | 70315 | 109 |
| ● 60x80 black | 87661 | 109 |

ESPEJOS LED



LED SAMSUNG

LUMEN



| cm | Ref. | PVP |
|----------|-------|------------|
| 60x70cm | 82219 | 140 |
| 80x70cm | 82220 | 170 |
| 100x70cm | 82221 | 201 |
| 120x70cm | 82222 | 248 |

LIGHT

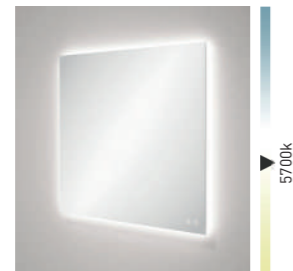

| cm | Ref. | PVP |
|----------|-------|------------|
| 60x70cm | 82548 | 173 |
| 80x70cm | 82549 | 186 |
| 100x70cm | 82550 | 206 |
| 120x70cm | 82551 | 221 |

SOUL



| cm | Ref. | PVP |
|----------|-------|------------|
| 60x80cm | 70084 | 278 |
| 80x80cm | 70085 | 326 |
| 100x80cm | 70086 | 370 |
| 120x80cm | 70087 | 406 |

FRAME



| cm | Ref. | PVP |
|----------|-------|------------|
| 60x80cm | 80208 | 213 |
| 80x80cm | 80209 | 239 |
| 100x80cm | 80222 | 249 |

CLOE



| cm | Ref. | PVP |
|---------|-------|------------|
| 60x70cm | 70082 | 228 |
| 80x70cm | 70083 | 268 |

PARIS

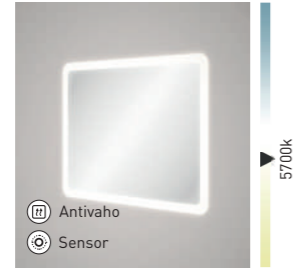

| cm | Ref. | PVP |
|----------|-------|------------|
| 60x60cm | 88942 | 279 |
| 80x60cm | 88943 | 292 |
| 100x60cm | 88944 | 312 |

LUNE

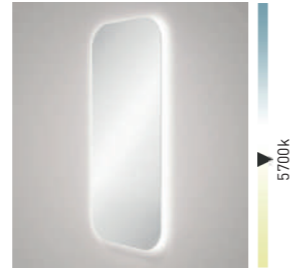

| cm | Ref. | PVP |
|-------------------|-------|------------|
| 50x120cm | 71971 | 203 |
| Sensor & Antivaho | | |
| 50x120cm | 71972 | 272 |

LOIRA



| cm | Ref. | PVP |
|-------------------|-------|------------|
| 50x80cm | 87666 | 233 |
| 50x80cm | 87667 | 233 |
| 50x80cm | 73490 | 244 |
| Sensor & Antivaho | | |
| 50x80cm | 87672 | 296 |
| 50x80cm | 87673 | 296 |
| 50x80cm | 73491 | 307 |

ADA

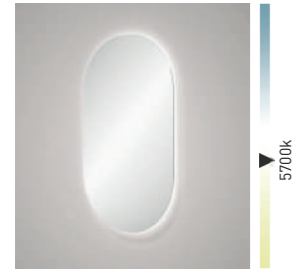

| cm | Ref. | PVP |
|---------|-------|------------|
| 50x80cm | 87218 | 177 |

BLUE

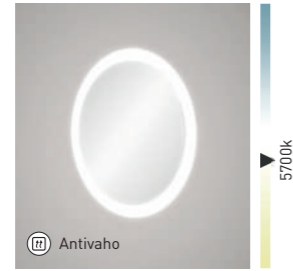

| cm | Ref. | PVP |
|---------|-------|------------|
| 70 ∅ cm | 84282 | 238 |

LISS

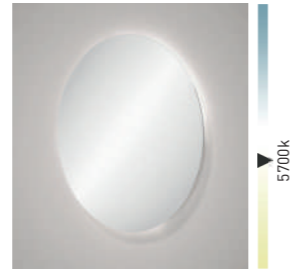

| cm | Ref. | PVP |
|---------|-------|------------|
| 50 ∅ cm | 72206 | 144 |
| 70 ∅ cm | 87408 | 170 |
| 80 ∅ cm | 87769 | 189 |
| 90 ∅ cm | 87407 | 216 |

ESPEJOS LED

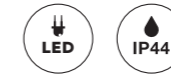

LED SAMSUNG

ALEXA

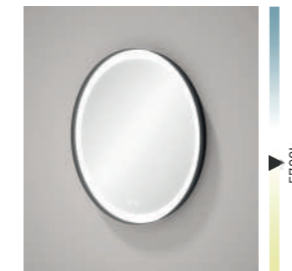

| cm | Ref. | PVP | Sensor & Antivaho |
|---------|-------|------------|--------------------------|
| 70 ∅ cm | 87681 | 226 | 70 ∅ cm 87668 290 |
| 70 ∅ cm | 87680 | 226 | 70 ∅ cm 87669 290 |
| 70 ∅ cm | 73485 | 236 | 70 ∅ cm 73486 299 |
| 80 ∅ cm | 73121 | 279 | 80 ∅ cm 73118 337 |
| 80 ∅ cm | 73120 | 279 | 80 ∅ cm 73119 337 |
| 80 ∅ cm | 74919 | 292 | 80 ∅ cm 74918 350 |
| 90 ∅ cm | 87683 | 295 | 90 ∅ cm 87670 359 |
| 90 ∅ cm | 87682 | 295 | 90 ∅ cm 87671 359 |
| 90 ∅ cm | 73487 | 309 | 90 ∅ cm 73488 373 |

VARIO



Regula la temperatura de luz pulsando el botón touch.

VARIO REDONDO

| cm | Ref. | PVP |
|---------|-------|------------|
| 60 ∅ cm | 73492 | 222 |
| 80 ∅ cm | 73493 | 290 |

VARIO CUADRADO

| cm | Ref. | PVP |
|-------|-------|------------|
| 60x60 | 73494 | 235 |
| 80x80 | 73495 | 319 |

APLIQUE NOVEDAD

CONVIERTE TU ESPEJO EN UN ESPEJO CON LUZ.



| cm | cod. | P. |
|-------|-------|-----------|
| 50 cm | 76660 | 57 |
| 70 cm | 76663 | 64 |
| 80 cm | 76666 | 66 |
| 90 cm | 76669 | 70 |

*Compatible con Espejo Ada y Liss.



| cm | cod. | P. |
|-------|-------|-----------|
| 60 cm | 76672 | 58 |
| 70 cm | 76675 | 62 |
| 80 cm | 76678 | 68 |
| 90 cm | 76681 | 71 |

*Compatible con Espejo Sevilla.

APLIQUES

ARYA



30 x 15 x 2,5 cm **Ref. 83446 PVP 34**

NEXT



30 x 11 x 1,5 cm **Ref. 82216 PVP 53**
 45 x 11 x 1,5 cm **Ref. 82217 PVP 63**
 60 x 11 x 1,5 cm **Ref. 82218 PVP 79**

OPORTO

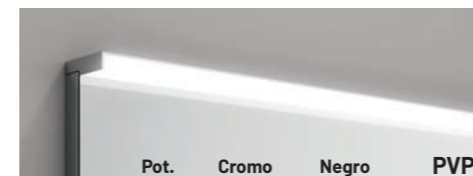

| Pot. | Cromo | Negro | PVP | |
|--------|-------|-------|-------|------------|
| 60 cm | 15W | 87652 | 87656 | 71 |
| 80 cm | 20W | 87653 | 87657 | 89 |
| 100 cm | 25W | 87654 | 87658 | 114 |
| 120 cm | 30W | 87655 | 87659 | 133 |

NOVA



30 x 8 x 2,5 cm **Ref. 84040 PVP 50**
 30 x 8 x 2,5 cm **Ref. 84041 PVP 50**

GLOW



Glow 90 cm **Ref. 71049 PVP 44**
 Glow 90 cm **Ref. 71194 PVP 44**

MIRANDA



| Pot. | Cromo | Negro | PVP |
|----------|-------|-------|--------------------------|
| 60x70 cm | | | Ref. 73590 PVP 68 |
| 80x70 cm | | | Ref. 73591 PVP 85 |
| 100x70cm | | | Ref. 73592 PVP 96 |

ACCESORIOS

SOPORTE EASY



| | Secador | Plancha |
|--------|-----------|-----------|
| Blanco | 88964 | 88967 |
| Cromo | 88962 | 88965 |
| Negro | 88963 | 88966 |
| PVP | 41 | 41 |

*Instalación sin taladro.
 No necesita elementos de fijación.

TOALLERO EASY



| | Ref. |
|--------|-----------|
| Blanco | 88961 |
| Cromo | 88959 |
| Negro | 88960 |
| PVP | 41 |

*Instalación sin taladro.
 No necesita elementos de fijación. Max. 5kg

ESTRUCTURA / PATAS



| | Ref. |
|--------|-----------|
| Blanco | 88973 |
| Negro | 88972 |
| PVP | 66 |

*El mueble debe ser fijado a la pared.
 Herraje de fijación incluidos.

VALVULA UNIVERSAL



| | Ref. | PVP |
|---------------------------|-------|-----------|
| Válvula universal - Cromo | 85112 | 20 |
| Válvula universal - Negro | 85113 | 30 |

ORGANIZADOR



| | Ref. | PVP |
|--------------------------|-------|-----------|
| Organizador 387x325x34mm | 82576 | 27 |

*Compatible con/Suitable for:
Box, Granada, Vision, Eleven y Aqua.

*No compatible con/Not suitable for:
Box de fondo reducido

CONJUNTOS CON LAVABO ADA



GRANADA 2C + LAVABO ADA

| | 60cm | | | 80cm | | | 100cm | | | 120cm 2 senos | | |
|------------|------------|------------|-----------|------------|------------|-----------|------------|------------|-----------|---------------|------------|-----------|
| | Tir. Alum. | Tir. Negro | Tir. Bco. | Tir. Alum. | Tir. Negro | Tir. Bco. | Tir. Alum. | Tir. Negro | Tir. Bco. | Tir. Alum. | Tir. Negro | Tir. Bco. |
| Aliso | 78282 | 78287 | 78292 | 78339 | 78344 | 78349 | 78354 | 78359 | 78364 | 78369 | 78374 | 78379 |
| Costa | 78283 | 78288 | 78293 | 78340 | 78345 | 78350 | 78355 | 78360 | 78365 | 78370 | 78375 | 78380 |
| Valenti | 78284 | 78289 | 78294 | 78341 | 78346 | 78351 | 78356 | 78361 | 78366 | 78371 | 78376 | 78381 |
| Bco-Ada | 78285 | 78290 | 78295 | 78342 | 78347 | 78352 | 78357 | 78362 | 78367 | 78372 | 78377 | 78382 |
| Ceniza | 78286 | 78291 | 78296 | 78343 | 78348 | 78353 | 78358 | 78363 | 78368 | 78373 | 78378 | 78383 |
| PVP | 315 | | | 359 | | | 435 | | | 575 | | |



GRANADA 2C SUELO + LAVABO ADA

| | 60cm | | | 80cm | | | 100cm | | |
|------------|------------|------------|-----------|------------|------------|-----------|------------|------------|-----------|
| | Tir. Alum. | Tir. Negro | Tir. Bco. | Tir. Alum. | Tir. Negro | Tir. Bco. | Tir. Alum. | Tir. Negro | Tir. Bco. |
| Aliso | 78447 | 78452 | 78457 | 78462 | 78467 | 78472 | 78477 | 78482 | 78487 |
| Costa | 78448 | 78453 | 78458 | 78463 | 78468 | 78473 | 78478 | 78483 | 78488 |
| Valenti | 78449 | 78454 | 78459 | 78464 | 78469 | 78474 | 78479 | 78484 | 78489 |
| Bco-Ada | 78450 | 78455 | 78460 | 78465 | 78470 | 78475 | 78480 | 78485 | 78490 |
| Ceniza | 78451 | 78456 | 78461 | 78466 | 78471 | 78476 | 78481 | 78486 | 78491 |
| PVP | 345 | | | 389 | | | 466 | | |



GRANADA 3C + LAVABO ADA

| | 60cm | | | 80cm | | | 100cm | | |
|------------|------------|------------|-----------|------------|------------|-----------|------------|------------|-----------|
| | Tir. Alum. | Tir. Negro | Tir. Bco. | Tir. Alum. | Tir. Negro | Tir. Bco. | Tir. Alum. | Tir. Negro | Tir. Bco. |
| Aliso | 78546 | 78551 | 78556 | 78561 | 78566 | 78571 | 78576 | 78581 | 78586 |
| Costa | 78547 | 78552 | 78557 | 78562 | 78567 | 78572 | 78577 | 78582 | 78587 |
| Valenti | 78548 | 78553 | 78558 | 78563 | 78568 | 78573 | 78578 | 78583 | 78588 |
| Bco-Ada | 78549 | 78554 | 78559 | 78564 | 78569 | 78574 | 78579 | 78584 | 78589 |
| Ceniza | 78550 | 78555 | 78560 | 78565 | 78570 | 78575 | 78580 | 78585 | 78590 |
| PVP | 385 | | | 445 | | | 525 | | |



BOX 2C + LAVABO ADA

| Acabado | 60cm | 80cm | 100cm | 120cm 2S |
|------------|------------|------------|------------|------------|
| B-ada | 78722 | 78729 | 78736 | 78743 |
| Ceniza | 78723 | 78730 | 78737 | 78744 |
| PVP | 306 | 349 | 421 | 569 |
| Abedul | 78724 | 78731 | 78738 | 78745 |
| Aliso | 78725 | 78732 | 78739 | 78746 |
| Costa | 78726 | 78733 | 78740 | 78747 |
| Valenti | 78727 | 78734 | 78741 | 78748 |
| Nieve Br. | 78728 | 78735 | 78742 | 78749 |
| PVP | 283 | 331 | 399 | 555 |

BOX 3C + LAVABO ADA

| Acabado | 60cm | 80cm | 100cm | 120cm 2S |
|------------|------------|------------|------------|------------|
| B-ada | 78860 | 78867 | 78874 | 78881 |
| Ceniza | 78861 | 78868 | 78875 | 78882 |
| PVP | 369 | 425 | 509 | 825 |
| Abedul | 78862 | 78869 | 78876 | 78883 |
| Aliso | 78863 | 78870 | 78877 | 78884 |
| Costa | 78864 | 78871 | 78878 | 78885 |
| Valenti | 78865 | 78872 | 78879 | 78886 |
| Nieve Br. | 78866 | 78873 | 78880 | 78887 |
| PVP | 351 | 399 | 475 | 785 |



PRODUCTOS EXPRESS / CONDICIONES

Se consideran productos con servicio Express aquellos que aparecen en este folleto, sólo en las medidas y combinaciones señaladas en **Rosa**.

Los productos y precios Promobath son sólo los que aparecen en este folleto. Para cualquier otra combinación o acabado, ver Catálogo General.

Servicio Express:

- . Recepción del pedido antes de la 13:00h: **servicio 48-72h**.
- . Recepción del pedido después de la 13:00h: **servicio 72-96h**.
- . Consultar servicio para las Islas Baleares, Canarias y Portugal.

Condiciones generales:

- . El cliente está obligado a revisar toda la mercancía una vez llega a sus instalaciones. En caso de detección de cualquier tipo de daño (aparente o no), o defectos de cantidad o calidad, el cliente deberá notificarlo vía correo electrónico a la empresa Visobath en un plazo máximo de 24h.
- . La garantía Visobath no cubre defectos o fallos causados por el instalador, usuario o cualquier otra persona en su manipulación.
- . Servicio contra stock sujeto a disponibilidad.
- . IVA no incluido en los precios.
- . No se aplicarán descuentos adicionales sobre los precios indicados en este folleto.
- . Los colores representados en este folleto pueden sufrir, debido a las técnicas de impresión, ligeras variaciones de tono respecto al material original.



Instalación muebles



Biobacter® - Kupsa
Lacado antibacterias



Venta y distribución
del mueble de baño



14-35-00215-CUC



C170186



NUEVO *Delta*

*Más moda
Más colecciones*

Catálogo 6.0



VISOBATH

www.visobath.com

